

1

2

3

4

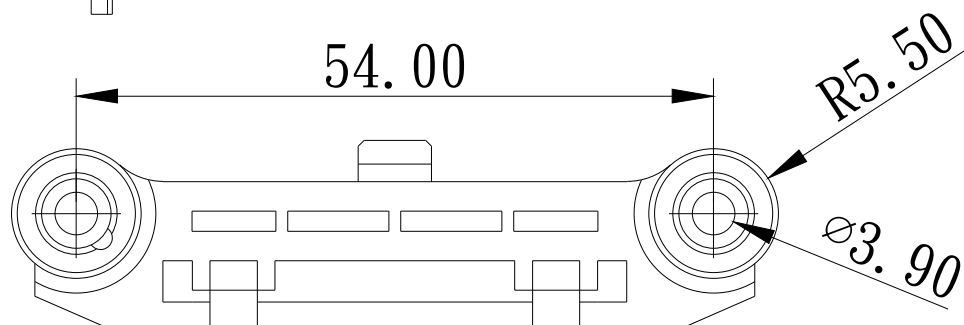
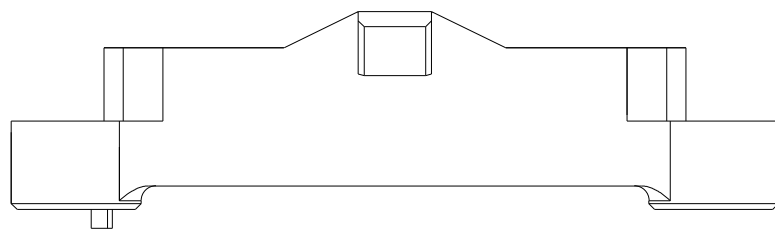
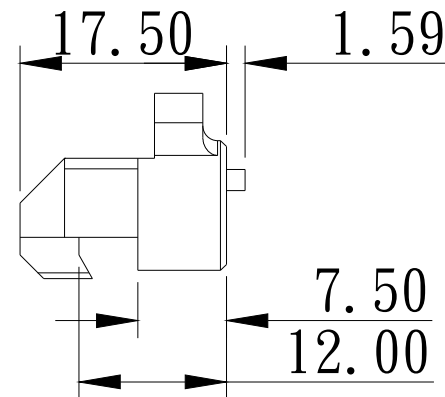
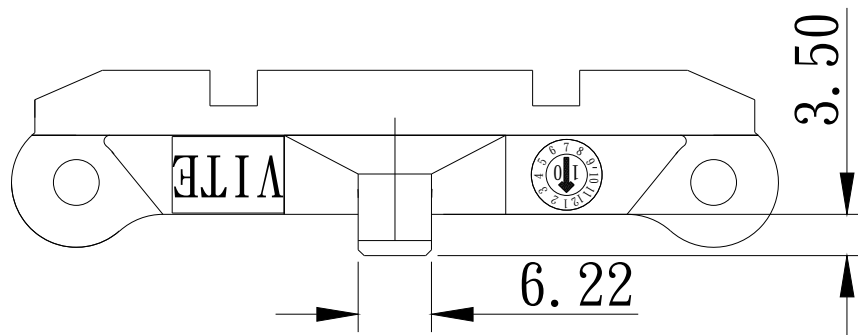
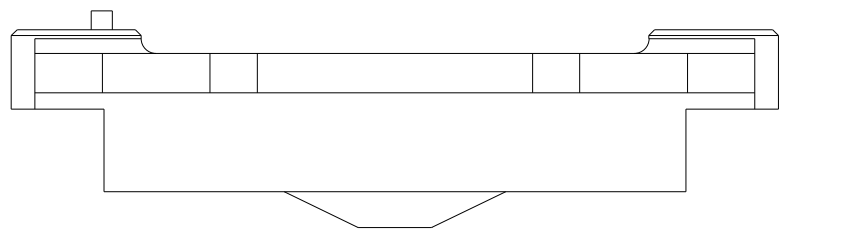

說明：

1. 材質: PC.
2. 顏色: 黑色
3. 卡扣拉斷力 $\geq 55\text{kgf}$.

ITEM	DESCRIPTION	Q' TY
01	R/M MATERIAL:PC (BLACK)	2
02	BACKPLATE:SPCC	1
03	SCREW:SAE 1018	4

廷奕科技股份有限公司
VITETECH CO., LTD

REV.	ECN. NO.	APP.	DATE
A	Official Publish	OW	MAY/25/11

RoHS COMPLIANT

DIMENSION CLASSIFICATION
 ◎:CRITICAL Ⓢ:MAJOR ():REFERENCE

REVISED	A	APPROVE	DATE
DRAW	CHK'D	ALAN	MAY/25/11
OW	JACK		

PRODUCT CUSTOMER COPY

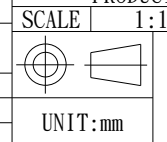

GENERAL TOLERANCE
 .X ±0.50 .X ±0.40
 .XX ±0.35
 .XXX ±0.05
 X' .X'

PART NO: 500-4110-989

DWG NAME:
AM4 BACKPLATE ASSY

1

2

3

4

1

2

3

4

A

A

B

B

C

C

D

D

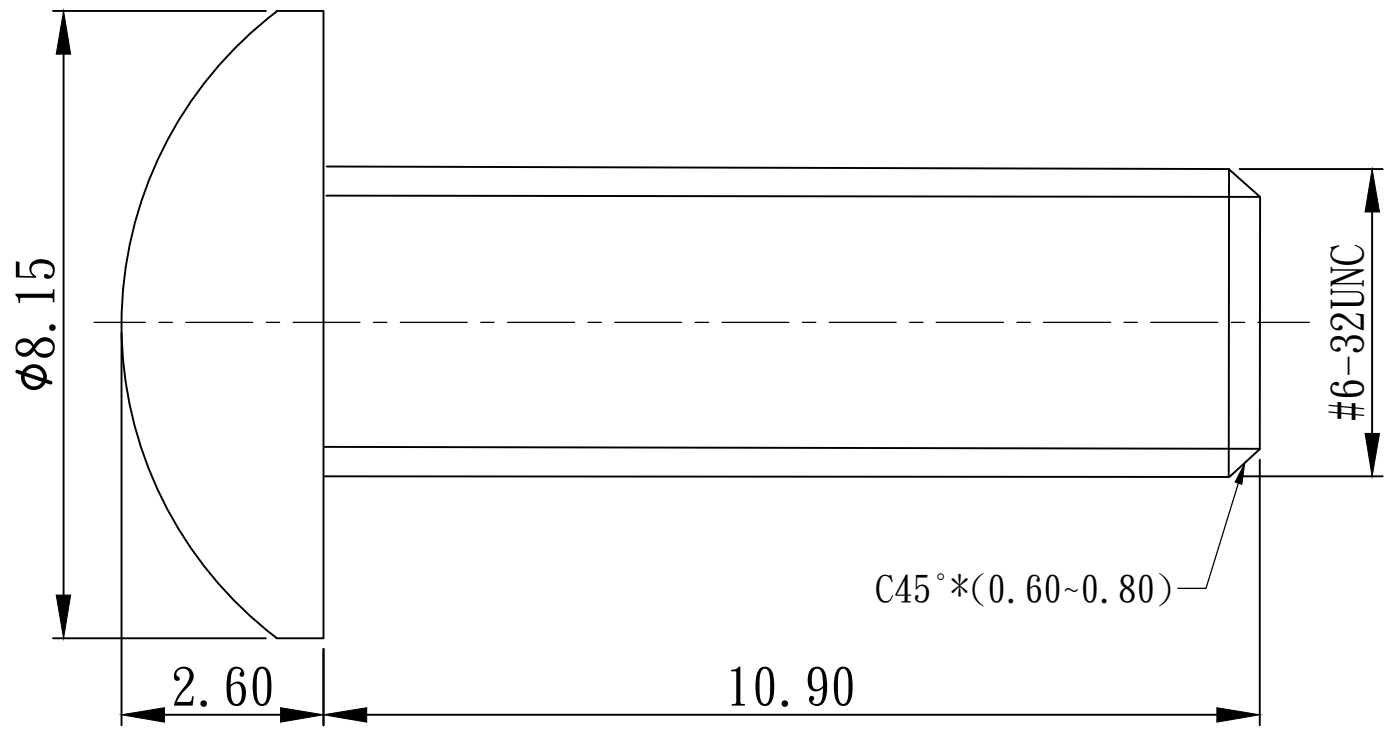
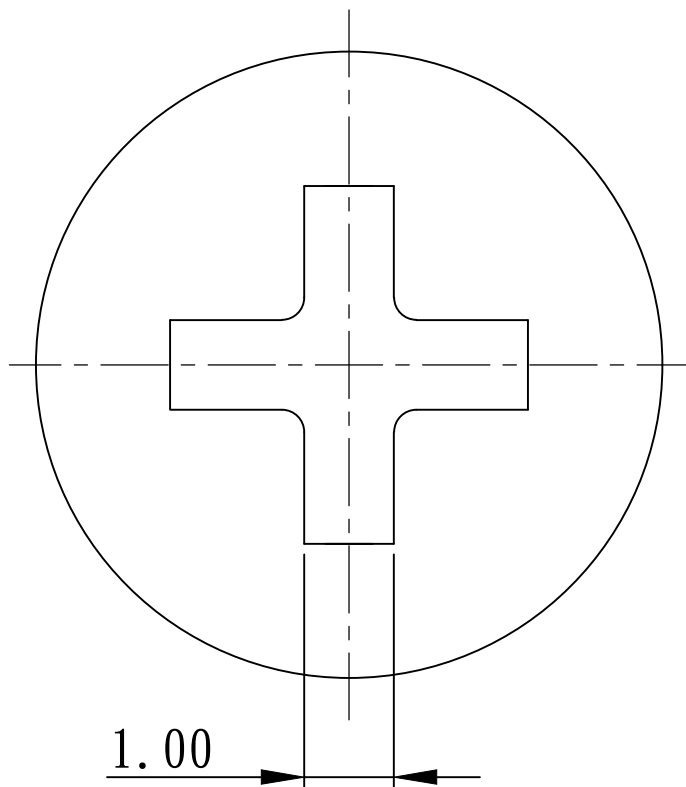

說明：

- 1.材質:SAE 1018
- 2.表面鍍鎳處理

廷奕科技股份有限公司
VITETECH CO., LTD

REV.	ECN. NO.	APP.	DATE
A	Official Publish	OW	MAY/25/11

RoHS COMPLIANT			
DIMENSION CLASSIFICATION			
Ⓢ : CRITICAL		Ⓜ : MAJOR () : REFERENCE	
REVISED	A		
DRAW	CHK' D	APPROVE	DATE
OW	JACK	ALAN	MAY/25/11

PRODUCT CUSTOMER COPY	
SCALE	1:1
SHEET	
GENERAL TOLERANCE	
X. ±0.50	.X ±0.40
.XX ±0.35	
.XXX ±0.05	
X.'	.X'

PART NO:	500-4110-989
DWG NAME:	AM4 BACKPLATE ASSY

1

2

3

4

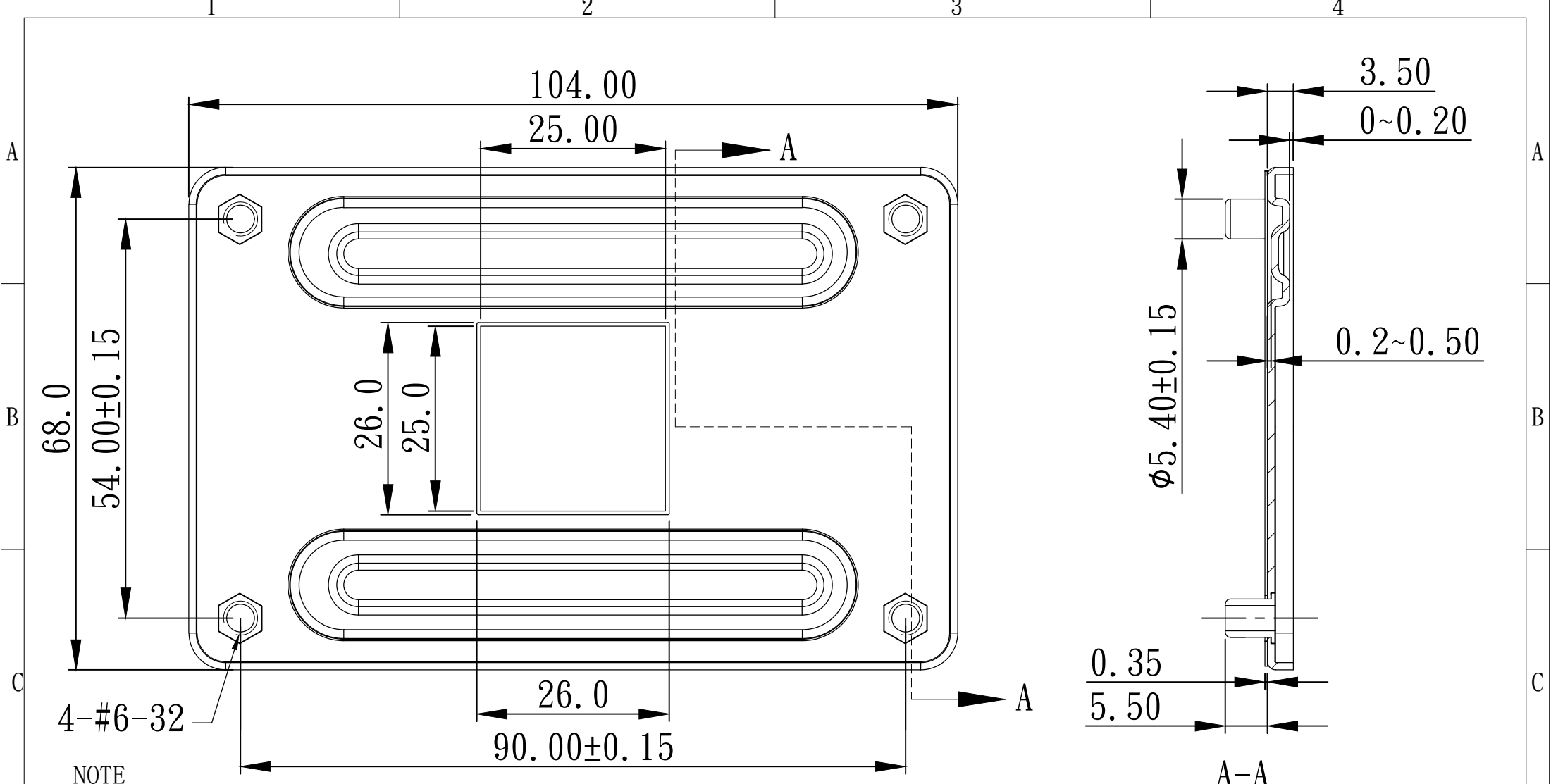

4-#6-32

NOTE

1. 背板材質:SPCC ,板厚1.0mm,
2. MYLAR: PET0.25+耐溫雙面膠,耐溫測試120° C 耐受24小時無溶膠現象。
3. 表面處理: 電泳黑色, 鹽霧測試24小時後無生銹、氧化現象。
4. 依據環境要求, 保證其環境管制物質符合<<RoHS環境管制物質管理規範>>標準。

廷奕科技股份有限公司
VITETECH CO., LTD

REV.	ECN. NO.	APP.	DATE
A	Official Publish	OW	MAY/25/11

RoHS COMPLIANT			
DIMENSION CLASSIFICATION			
Ⓞ: CRITICAL		Ⓜ: MAJOR (): REFERENCE	
REVISED	A		
DRAW	CHK' D	APPROVE	DATE
OW	JACK	ALAN	MAY/25/11

PRODUCT CUSTOMER COPY	
SCALE	1:1
SHEET	
GENERAL TOLERANCE	
X. ±0.50	.X ±0.40
.XX ±0.35	
.XXX ±0.05	
X.'	.X'

PART NO:	500-4110-989
DWG NAME:	AM4 BACKPLATE ASSY